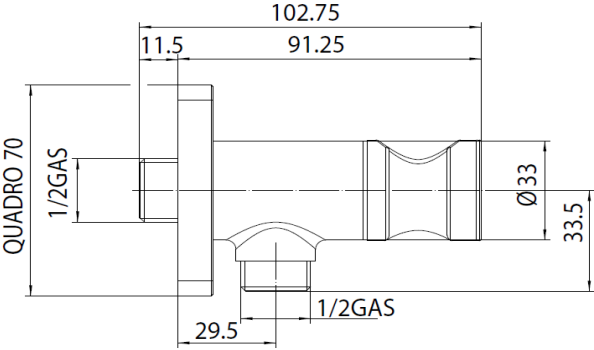
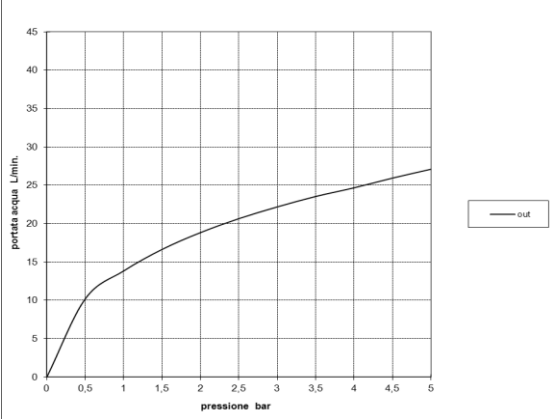

BOSSINI		SCHEDA TECNICA TECHNICAL SHEET		Date: 19/02/2016	Rev/0																										
Codice / Code: E42000		Descrizione / description: Rubinetto d'arresto da 1/2" M con vitone a dischi di ceramica con supporto doccia 1/2" M Stop valve with ceramic discs headwork and with shower holder																													
Foto / image		Disegni / drawings																													
																															
Grafico di portata / Flow rate diagram																															
<table border="1"> <thead> <tr> <th></th> <th>out</th> </tr> </thead> <tbody> <tr><td>0</td><td>0</td></tr> <tr><td>0,5</td><td>10,2</td></tr> <tr><td>1</td><td>13,8</td></tr> <tr><td>1,5</td><td>16,6</td></tr> <tr><td>2</td><td>18,8</td></tr> <tr><td>2,5</td><td>20,7</td></tr> <tr><td>3</td><td>22,2</td></tr> <tr><td>3,5</td><td>23,5</td></tr> <tr><td>4</td><td>24,7</td></tr> <tr><td>4,5</td><td>25,9</td></tr> <tr><td>5</td><td>27,1</td></tr> <tr> <td>pressione bar</td> <td>portata L/min</td> </tr> </tbody> </table>			out	0	0	0,5	10,2	1	13,8	1,5	16,6	2	18,8	2,5	20,7	3	22,2	3,5	23,5	4	24,7	4,5	25,9	5	27,1	pressione bar	portata L/min				
	out																														
0	0																														
0,5	10,2																														
1	13,8																														
1,5	16,6																														
2	18,8																														
2,5	20,7																														
3	22,2																														
3,5	23,5																														
4	24,7																														
4,5	25,9																														
5	27,1																														
pressione bar	portata L/min																														
MATERIALI / materials																															
Brass																															
CARATTERISTICHE IDRAULICHE / hydraulic features																															
	pressione pressure	portata flow rate	temperatura temperature	solo per miscelatori termostatici only for thermostatic mixers																											
min	1 bar	L/min	--	Blocco di sicurezza safety lock	/																										
max	5 bar	L/min	<70°C	Temperatura acqua fredda cold water temperature	/																										
consigliata recommended	2-3 bar	L/min	--	Temperatura acqua calda hot water temperature	/																										
CERTIFICAZIONI / CERTIFICATIONS:																															
CONFORMITA' / CONFORMITY . EN 200 - Chrome plating EN 248																															